

# SBP2CPY24



## Dupline® web-based server for Carpark



### Benefits

- Micro PC with web server capability
- Linux-embedded operating system
- Distributed installations management (up to 10)
- Database replica from up to 10
- Data export in Excel® format
- One Ethernet port
- One multipurpose USB 2.0 ports
- 12 to 28 VDC power supply
- Dimensions: 2-DIN modules
- Protection degree (front): IP40

### Description

The SBP2CPY24 is a micro PC with a web server and web service capabilities suitable to gather information from up to ten SBP2WEB24s.

The SBP2CPY24 aggregates data from multiple installations in a single, centralised database, allowing the user to access them anywhere by a standard web browser, through a highly interactive interface.

All data are available as charts, tables and reports based on XLS format.

### Applications

Parking Guidance Systems

### Main functions

- The Carpark Server SBP2CPY24 is used in car park applications to monitor/control informations from up to 10 Carpark controllers SBP2WEB24.

**Structure**

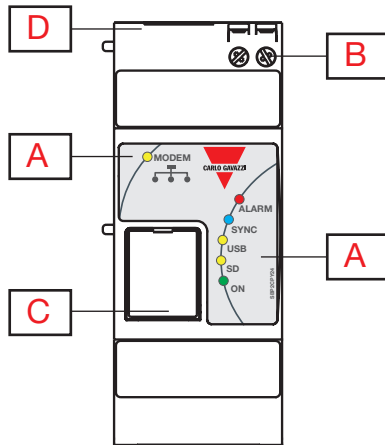

Element	Component	Function
A	LED	Green LED: Power ON Yellow LED: Modem Blue LED: Synchronization with SBP2WEB24 Yellow LED: USB Yellow LED: Micro SD Red LED: Alarms
B	Screw terminal	For power supply
C	Micro SD holder	Slot to plug-in the proper micro SD or micro SDHC memory and mini USB connector.
D	USB and RJ connector	USB "A" type connector and RJ45 10/100 BaseTX connector for Ethernet communication.

**Main hardware characteristics**

<b>Memory</b>	
Flash (data)	32 GB
RAM	128 MB (internal)
<b>Communication ports</b>	
Ethernet	According to ISO9847
<b>Other ports</b>	
Mini USB	1, "D" device function for PC connection



## Features

### Power Supply

Power supply	15- 24 VDC ( $\pm 20\%$ ), 0.2 A, CL.2
Consumption	$\leq 5$ W

### Input/output isolation

Type of input/output	DC Power supply	Ethernet	USB port "D" (service)
DC Power supply	-	0.5 kV	0 kV
Ethernet (LAN/Internet)	0.5 kV	-	0.5 kV
USB port "H" (host)	0 kV	0.5 kV	-
USB port "D" (service)	0 kV	0.5 kV	-

- 0 kV: inputs/outputs are not insulated
- 0.5 kV rms: the insulation is functional type

### LEDs indication

Type	Status	Single colour LED Changing according to the function
<b>Controlled functions</b>	Power supply, USB port, SD port, alarms, database synchronization with SBP2WEB24	
<b>Colour code and working mode</b>	Power ON	<b>Green LED</b> Steady ON: power supply is on
	Modem	<b>Yellow LED</b> Steady ON: SD card is present Steady OFF: SD card is not present Blinking: communication mode active
	Sync (SBP2WEB24 Database)	<b>Blue LED</b> Steady ON: SBP2CPY24 receives data from all connected SBP2WEB24s Steady OFF: SBP2CPY24 does not receive any data from any SBP2WEB24 Blinking: SBP2CPY24 receives data from at least one SBP2WEB24
	Alarm	<b>Red LED</b> Steady ON: alarms without acknowledgement in progress Steady OFF: no alarms without acknowledgement

**Environmental**

<b>Ambient temperature</b>	-25°... +65°C (-13°... +158°F)	Operating
	-30° ... +70°C (-22° ... +158°F) (R.H. < 90% non-condensing @ 40°C)	Storage
<b>Insulation (for 1 minute)</b>	See table "input/output Insulation"	
<b>Dielectric strength</b>	4000 VAC rms	for 1 min.
<b>Noise rejection (CMRR)</b>	>65dB	45 to 65 Hz
<b>Overvoltage category</b>	III	IEC60664; EN60664. For inputs from string: equivalent to Cat. I, reinforced insulation.

**EMC**

<b>Immunity</b>	EN61000-6-2
<b>Emission</b>	EN61000-6-3



## Ports

### USB

<b>Type</b>	High speed 2.0 ( $\leq 250$ mA)
<b>Working type</b>	Hot swap
<b>Communication speed</b>	60MB/s (480Mbits/s)
<b>Connections</b>	"Mini A" type as "Device" function on the front of the housing protected by front cover
<b>Device function (mini USB)</b>	Available on the "D" USB port only, it is a virtual Ethernet port and works as a real Ethernet port performing all the functions of the main Ethernet port.

### Ethernet

<b>Protocol</b>	HTTP
<b>IP configuration</b>	Static IP / Netmask / Default gateway
<b>DNS</b>	Primary and secondary DNS as a static or dynamic management (using DHCP server if configured)
<b>Client connections</b>	Max 20 simultaneously
<b>Connections</b>	RJ45 10/100 BaseTX, Max. distance: 100m
<b>Insulation</b>	See "Input/output insulation" table

## Data recording

### ▶ Memory format and data occupancy

Description	Value
Total available memory for database and events	32 GB
Maximum backup size (on SD or USB)	32 GB
Resolution	15 min
Database size management	Dynamic, based on: -Current number of SBP2WEB24 units which are replicating their database to SBP2CPY24 -Data resolution (15 minutes)
Range of historical data available with High resolution	4 years
Range of historical data available with Low resolution	30 years

## TCP/IP networking

### Inbound TCP/IP communication

TCP/IP port number	TCP/IP port description	Purpose
80	HTTP	Access to the internal web-server
52325	SSH	Remote tunneling feature; connection from SBP2WEB24 to SBP2CPY24

### Outbound TCP/IP communication

TCP/IP port number	TCP/IP port description	Purpose
53	DNS	Domain name resolution
37	NTP	Network time services access
25	SMTP	Email message dispatching



## Web interface

### Main functions

<b>Overall features</b>	Database storage from up to 10 SBP2WEB24 units; access by web interface to present real time and historical data for all the carpark devices connected to the SBP2WEB24 units	
<b>Database synchronization</b>	Communication protocol	WEBAPI
	Replication direction	Data push from SBP2WEB24 to SBP2CPY24 so as to avoid firewall hassles
	Internet connection SBP2CPY24	Mobile and wired communication (mobile communication allowed only to access the web interface for maintenance)
<b>Configuration</b>	The configuration of SBP2CPY24 can be carried by using its integrated web server. No additional configuration software is needed. Configuration of SBP2WEB24 units which exchange data with SBP2CPY24 is made by connecting to the SBP2WEB24's web server <sup>(1)</sup>	
<b>Clock</b>	Functions	Universal clock and calendar with automatic synchronisation through Internet connection
	Battery life	10 years
<b>Data and Events logging</b>	Memory size	32 GB
	Storage duration and interval	See "SBP2CPY24 memory format and data occupancy"
	Storage data types	According to SBP2WEB24 <sup>(1)</sup>
<b>Alarms management</b>	Overview	Local alarm management performed by SBP2WEB24 units and/or centralised alarm management based on SBP2CPY24 is possible. Local alarm management is based on SBP2WEB24 functions <sup>(1)</sup> Centralised alarm management allows to send by email alarm queues coming from the SBP2WEB24 unit
<b>Data access</b>	User interface	Web server access by web browser (Firefox, Chrome, Explorer, Opera, Safari supported)
	Data Export	Direct export from charts to CSV files Database export to XLS, JPEG, PNG, PDF, SVG files
<b>User management</b>	Concurrent users	Up to 20
	Users profiling	Standard user with access to data and administrators with access to configuration.
	Internationalisation	Multilingual interface

### Notes

<sup>(1)</sup>: Please check the relevant SBP2WEB24 documentation for further information



**Web server**

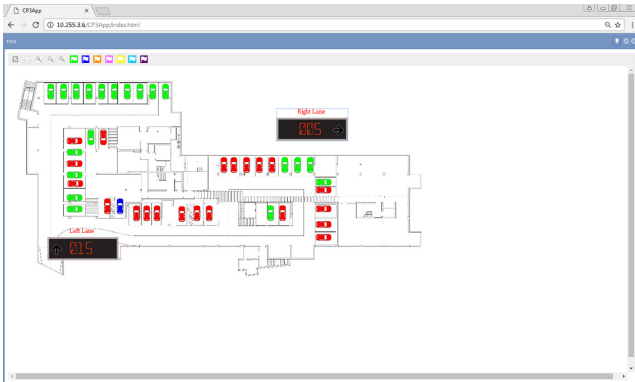

**Home page including:**  
 -Main toolbar on the top  
 -Hierarchical tree view on the right  
 -Main variables boxes on the left  
 -Alarms view at the bottom  
 -Map view in the centre

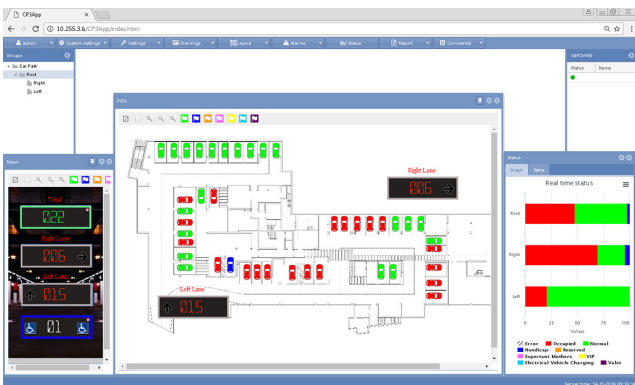

**Monitor view**  
 Each Carpark sensor can be inspected about present and historical trends of any single variable, in the desired time interval

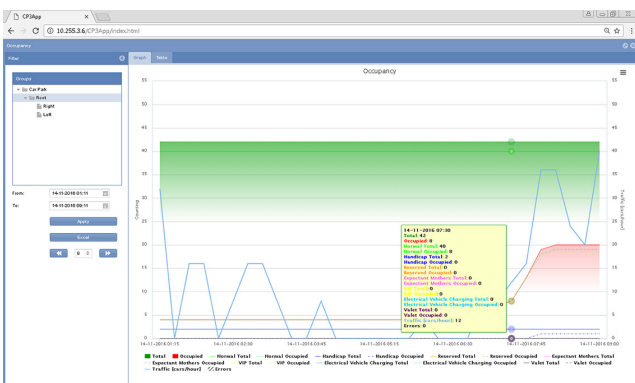

**Analysis view**  
 Trends charting tool, allowing to show and compare any combination of variables from one or multiple Carpark sensors

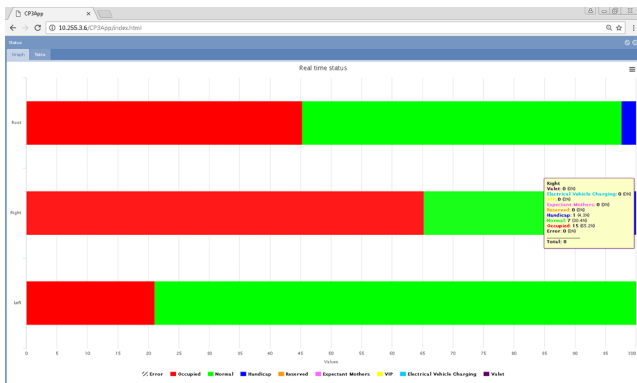

### Status

The user can observe the status of the entire car park or the individual lanes

## Mechanics

### Housing

<b>Dimensions (HxWxD)</b>	35.5 (0.5 - 0) x 90 x 67 mm	
<b>Housing material</b>	Noryl, self-extinguishing V-0 (UL94)	
<b>Mounting</b>	DIN rail	
<b>Degree of protection</b>	Front	IP40
	Screw terminal	IP20
<b>Weight</b>	< 600 g	

### Dimensions (mm)

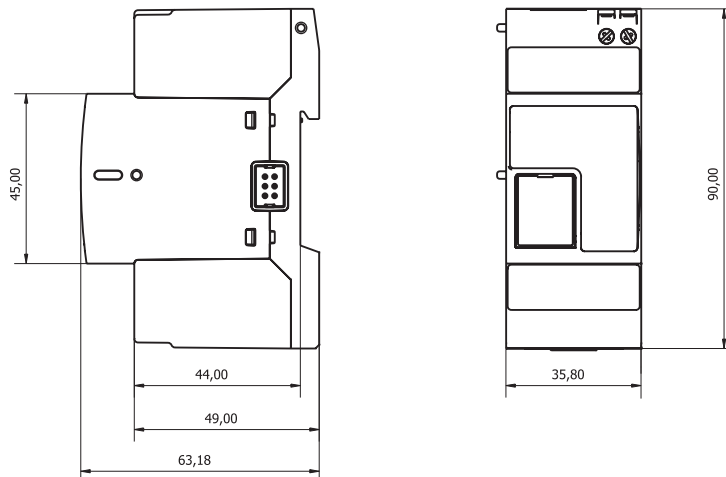

### Connection

<b>Ethernet</b>	RJ-45 connector (10/100 Base-T)
<b>USB</b>	High speed USB 2.0
<b>power supply</b>	2 screw terminals 1,5mm <sup>2</sup> max. min/max.screw tightening torque:0,4 Nm/ 0,8Nm

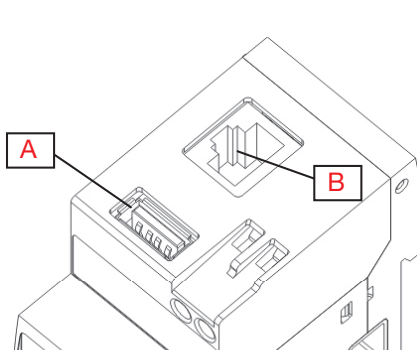

Fig. 1 USB host and LAN port

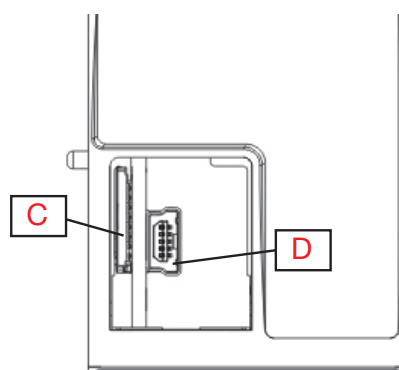

Fig. 2 Micro SD slot and mini USB

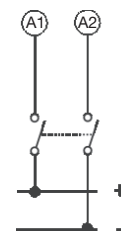
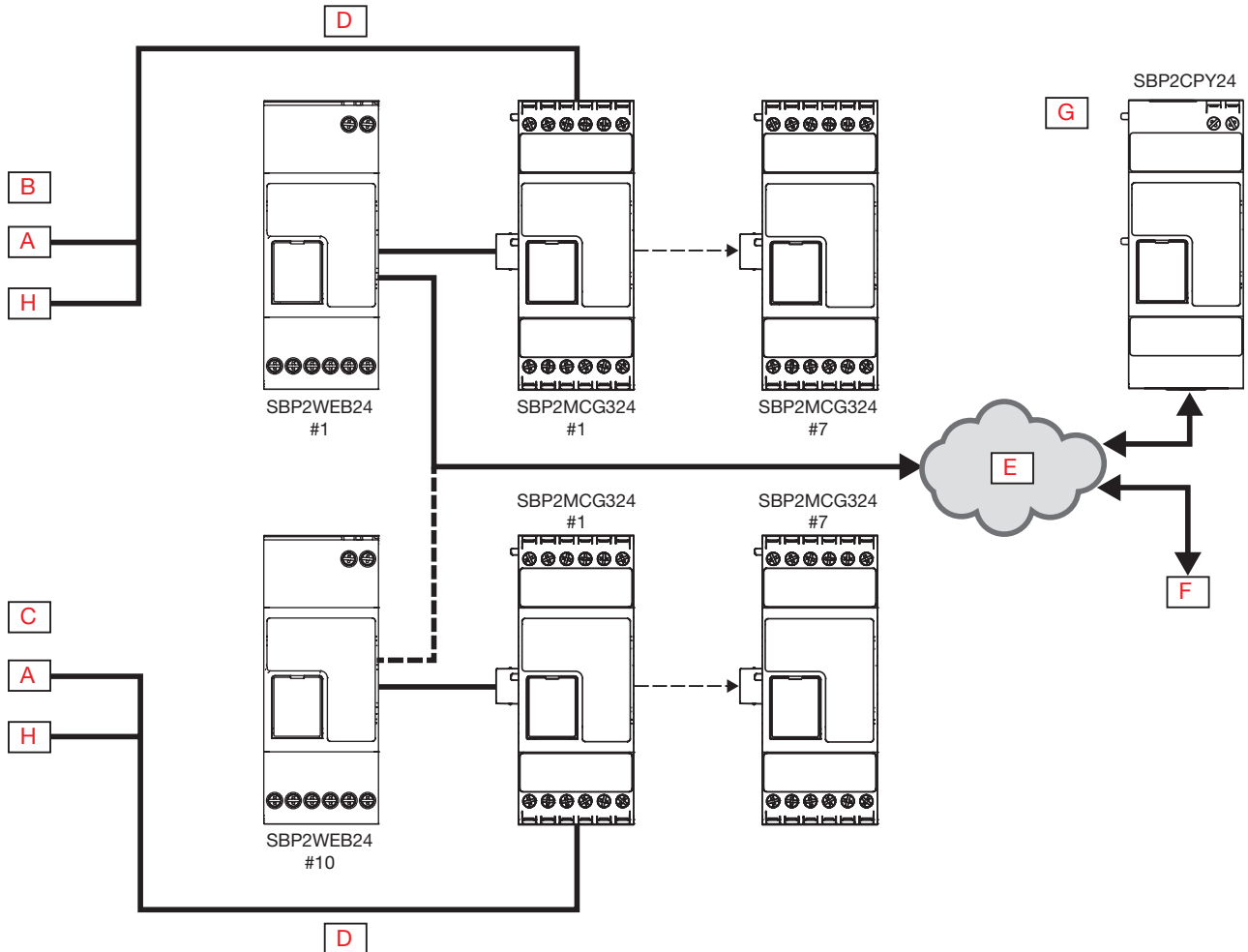

Fig. 3 power supply



A	USB host	C	Micro SD slot
B	LAN port	D	Mini USB

**Wiring**



A	50 Sensors	E	Internet
B	Installation 1	F	Computer
C	Installation 10	G	Centralized database User interface Data management tools
D	3-wire Dupline®	H	40 Sensors

## Compatibility and conformity

### Approvals and markings

CE-marking	
Approvals	

#### UL notes

- This product is intended to be supplied by a Listed Information Technology Equipment AC Adaptor marked NEC Class 2 or LPS
- Max ambient temperature: 50°C (122°F)



## References

 Product selection key

 SBP2CPY24

COPYRIGHT ©2016  
Content subject to change.